

Instruction Manuals

Lakes End

www.cotswoldretreats.com

DISR 14B1

GB English

Operating instructions

DISHWASHER - Contents

Operating instructions, 1
Precautions and advice, 2-3
Product Data, 3
Installation, 4-5
Electrical connection, 6
Description of the appliance, 7
Refined salt and rinse aid, 8
Loading the racks, 9-10
Detergent and dishwasher use, 11
Wash cycles, 12
Care and maintenance, 13
Troubleshooting, 14
Product Guarantee and Repair Information, 15

Detergent and dishwasher use

Measuring out the detergent

Good washing results also depend on the correct amount of detergent being used. Exceeding the stated amount does not result in a more effective wash and increases environmental pollution.

The amount can be adjusted to the soil level.

In the case of normally soiled items, use approximately either 25g (powder detergent) or 25ml (liquid detergent). If tablets are used, one tablet will be enough.

If the crockery is only lightly soiled or if it has been rinsed with water before being placed in the dishwasher, reduce the amount of detergent used accordingly.

For good washing results also follow the instructions shown on the detergent box.

For further questions please ask the detergent producers.

Open the detergent dispenser using button **D** and measure out the detergent according to the Table of wash cycles:

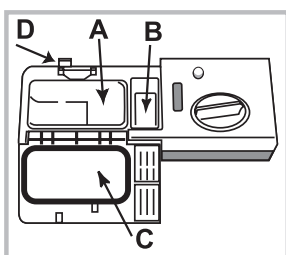

- powder or liquid: compartments **A** (wash detergent) and **B** (pre-wash detergent)
- tablets: when the cycle requires 1 tablet, place it in compartment **A** and close cover **C**; when it requires 2 tablets, place the second tablet on the bottom of the appliance.

Remove detergent residues

from the edges of the compartment and close cover **C** until it clicks.

The detergent dispenser automatically opens up at the right time according to the wash cycle.

If all-in-one detergents are used, we recommend using the TABS option, because it adjusts the cycle so that the best washing and drying results are always achieved.

 **Only use detergent which has been specifically designed for dishwashers.**

DO NOT USE washing up liquid.

Using excessive detergent may result in foam residues remaining in the machine after the cycle has ended.

To achieve the best washing and drying results, the combined use of detergent, rinse aid liquid and refined salt is required.



We recommend using detergents that do not contain phosphates or chlorine, as these products are harmful to the environment.

Starting the dishwasher

1. Turn the water tap on.
2. Open the door and press the ON/OFF button.
3. Measure out the detergent. (see adjacent information).
4. Load the racks (see *Loading the racks*).
5. Select the wash cycle in accordance with the type of crockery and its soil level (see *Table of wash cycles*) by pressing the **P** button.
6. Select the wash options*. (see *Special wash cycles and Options*).
7. Start the wash cycle by shutting the door.
8. The end of the wash cycle is indicated by beeps and by the flashing of the indicator light of the selected wash cycle. Open the door, switch off the appliance by pressing the ON/OFF button, shut off the water tap and unplug the appliance from the electricity socket.
9. Wait a few minutes before removing the crockery in order to avoid burns. Unload the racks, beginning with the lower level.

 **The machine will switch off automatically during long periods of inactivity in order to minimise electricity consumption.**

 If the crockery is only lightly soiled or if it has been rinsed with water before being placed in the dishwasher, reduce the amount of detergent used accordingly.

Changing a wash cycle in progress

If a mistake was made in the wash cycle selection process, it is possible to change the cycle provided that it has only just begun: open the door, taking care to avoid the escaping steam, and press and hold the ON/OFF button; the machine will switch off. Switch the machine back on using the ON/OFF button and select the new wash cycle and any options desired; start the cycle by closing the door.

Adding extra crockery

Without switching off the machine, open the door, taking care to avoid the escaping steam, and place the crockery inside the dishwasher. Close the door: the cycle starts from the point at which it was interrupted.

Accidental interruptions

If the door is opened during the wash cycle or there is a power cut, the cycle stops. It starts again from the point at which it was interrupted once the door has been shut or the electricity supply restored.

* Only available in selected models.





Wash cycles

GB

Wash-cycle data is measured under laboratory conditions according to European Standard EN 50242.

Based on the different conditions of use, the wash-cycle duration and data can change.

⚠ The number and type of wash cycles and options may vary depending on the dishwasher model.

Wash cycle	Wash cycle which include drying	Options	Approximate duration of wash cycles	Water consumption (l/cycle)	Energy consumption (kWh/cycle)
Eco 	Yes	No	02:10'	10	0,83
Intensive 	Yes	No	02:30'	14	1,3
Normal 	Yes	No	02:00'	13,5	1,1
Prewash 	No	No	00:10'	4,0	0,01

Instructions on wash cycle selection and detergent dosage

1. The ECO wash cycle is the standard cycle to which the energy label data refers. It can be used to wash crockery with a normal soil level and it is the most efficient cycle in terms of energy and water consumption for this type of crockery. 4 gr/ml**+ 21 gr/ml – 1 Tab (**Quantity of pre-washing detergent)

2. Heavily soiled dishes and pans (not to be used for delicate items). 25 gr/ml – 1 Tab

3. Normally soiled pans and dishes. 4 gr/ml**+ 21 gr/ml – 1 Tab

4. Pre-wash for dishes while awaiting completion of the load with the dishes from the next meal. No detergent

Standby consumption: Left-on mode consumption: 5 W - Off mode consumption: 0.5 W

Notes:

To reduce consumption, only run the dishwasher when it is full.

Note for Test Laboratories: for information on comparative EN testing conditions, please send an email to the following address: assistenza_en_lvs@indesitcompany.com

Shutting off the water and electricity supplies

- Turn off the water tap after every wash cycle to avoid leaks.
- Always unplug the appliance when cleaning it and when performing maintenance work.

Cleaning the dishwasher

- The external surfaces of the machine and the control panel can be cleaned using a non-abrasive cloth which has been dampened with water. Do not use solvents or abrasive products.
- Any marks on the inside of the appliance may be removed using a cloth dampened with water and a little vinegar.

Preventing unpleasant odours

- Always keep the door of the appliance ajar in order to avoid moisture from forming and being trapped inside the machine.
- Clean the seals around the door and detergent dispensers regularly using a damp sponge. This will avoid food becoming trapped in the seals, which is the main cause behind the formation of unpleasant odours.

Cleaning the spray arms

Food residue may become encrusted onto the spray arms and block the holes used to spray the water. It is therefore recommended that you check the arms from time to time and clean them with a small non-metallic brush.

The two spray arms may both be removed.

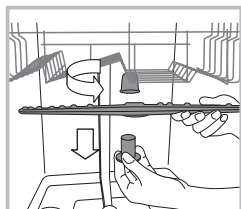

To remove the upper spray arm, turn the plastic locking ring in an anti-clockwise direction. The upper spray arm should be replaced so that the side with the greater number of holes is facing upwards.

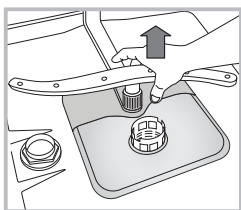

The lower spray arm can be removed by pressing on the side tabs and pulling it upwards.

Cleaning the filters

The filter assembly consists of three filters which remove food residues from the washing water and then recirculate the water. They must be cleaned if you wish to achieve the best results in every wash.

Clean the filters regularly.

The dishwasher must not be used without filters or if the filter is loose.

- After several washes, check the filter assembly and if necessary clean it thoroughly under running water, using a non-metallic brush and following the instructions below:

1. Turn the cylindrical filter **C** in an anti-clockwise direction and pull it out (fig. 1).
2. Remove the cup filter **B** by exerting a slight pressure on the side flaps (fig. 2);
3. Slide out the stainless-steel plate filter **A**. (fig. 3).
4. Inspect the trap and remove any food residues. **NEVER REMOVE** the wash-cycle pump protection (black detail) (fig.4).

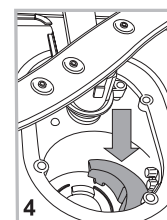
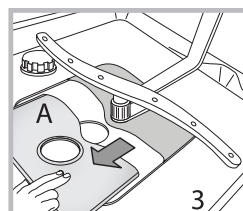
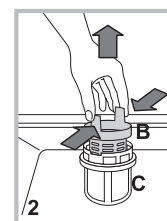
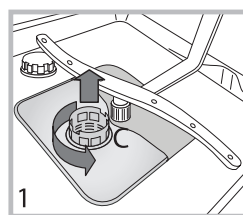

After cleaning the filters, re-place the filter assembly and fix it in position correctly; this is essential for maintaining the efficient operation of the dishwasher.

Leaving the machine unused for extended periods

- Disconnect the appliance from the electricity supply and shut off the water tap.
- Leave the door of the appliance ajar.
- When you return, run a wash cycle when the dishwasher is empty.

Cleaning the water inlet hose*

If the water hoses are new or have not been used for an extended period of time, let the water run to make sure it is clear and free of impurities before performing the necessary connections. If this precaution is not taken, the water inlet could become blocked and damage the dishwasher.

Clean the water inlet filter at the tap outlet regularly.

- Turn off the water tap.
- Unscrew the end of the water inlet hose, remove the filter and clean it carefully under running water.
- Re-place the filter and screw the water hose back into position.

* Only available in selected models.

Troubleshooting

GB

Whenever the appliance fails to work, check for a solution from the following list before calling for Assistance.

Problem:	Possible causes / Solutions:
The dishwasher does not start or cannot be controlled.	<ul style="list-style-type: none"> • The water supply tap is not turned on. • Switch off the appliance by pressing the ON/OFF button, switch it back on after approximately one minute and reset the wash cycle. • The appliance has not been plugged in properly or another electricity socket should be used. • The dishwasher door has not been closed properly.
The door won't close.	<ul style="list-style-type: none"> • Make sure that the racks were inserted all the way. • The lock was released. Strongly push the door until a "clacking" noise is heard.
No water drain out of the dishwasher.	<ul style="list-style-type: none"> • The wash cycle has not finished yet. • The water drain hose is bent (<i>see Installation</i>). • The drain duct is clogged up. • The filter is clogged up with food residues. • Check the height of the drain hose.
The dishwasher makes excessive noise.	<ul style="list-style-type: none"> • The dishes are rattling against each other or against the spray arms. Place the dishes properly and make sure the spray arms can rotate freely. • Too much foam: the detergent has not been measured out correctly or it is not suitable for use in dishwashers. (<i>See Detergent and dishwasher use.</i>) Do not prewash the dishes by hand.
The dishes and glasses are covered in a white film or limescale deposits.	<ul style="list-style-type: none"> • No refined salt. • Water hardness adjustment is not suitable: increase the relevant values. (<i>See Refined Salt and Rinse Aid.</i>) • The salt and rinse-aid dispenser cap has not been closed properly. • The rinse aid has been used up or the dosage is too low.
The dishes and glasses are streaked or have a bluish tinge.	<ul style="list-style-type: none"> • The rinse aid dosage is too high.
The crockery has not been dried properly.	<ul style="list-style-type: none"> • A wash cycle without a drying programme has been selected. • The rinse aid has been used up. (<i>See Refined Salt and Rinse Aid.</i>) • The rinse aid dispenser setting is not suitable. • The crockery is made from non-stick material or plastic; the presence of water drops is normal.
The dishes are not clean.	<ul style="list-style-type: none"> • The crockery has not been arranged properly. • The spray arms cannot rotate freely, being hindered by the dishes. • The wash cycle is too gentle (<i>see Wash Cycles</i>). • Too much foam: the detergent has not been measured out correctly or it is not suitable for use in dishwashers. (<i>See Detergent and dishwasher use.</i>) • The lid on the rinse aid compartment has not been closed correctly. • The filter is dirty or clogged up (<i>see Care and maintenance.</i>) • The refined salt level is low (<i>See Refined Salt and Rinse Aid.</i>) • Make sure that the height of the dishes is compatible with the rack adjustment. • The holes in the spray arms are clogged up. (<i>See Care and maintenance.</i>)
The dishwasher won't load any water. It is blocked with flashing lights.	<ul style="list-style-type: none"> • There is no water in the mains supply or the tap is shut off. • The water inlet hose is bent (<i>see Installation</i>). • The filters are clogged up: they need cleaning. (<i>See Care and maintenance.</i>) • The drain duct is clogged up: it needs cleaning. • After checking and cleaning, switch the dishwasher on and off and start a new wash cycle. • If the problem persists, turn off the water tap, remove the plug and call the Service Centre.

* Only available in selected models.

Instructions for use

WASHING MACHINE

GB

GB

English, 1

IWME 127

Contents

Installation, 2-3-4-5-6-7

Unpacking and levelling
Electric and water connections
The first wash cycle
Technical details
Instructions for the fitter

Care and maintenance, 8

Cutting off the water or electricity supply
Cleaning your appliance
Cleaning the detergent dispenser
Caring for your appliance door and drum
Cleaning the pump
Checking the water inlet hose

Precautions and advice, 9

General safety
Disposal
Saving energy and respecting the environment

Washing machine description, 10-11

Control panel
Leds

Starting and Programmes, 12

Briefly: how to start a programme
Programme table

Personalisations, 13

Setting the temperature
Setting the spin speed
Functions

Detergents and laundry, 14

Detergent dispenser
Bleach cycle
Preparing your laundry
Special items

Troubleshooting, 15-16

Product Guarantee and Repair Information, 17

Washing machine description

GB

Control panel

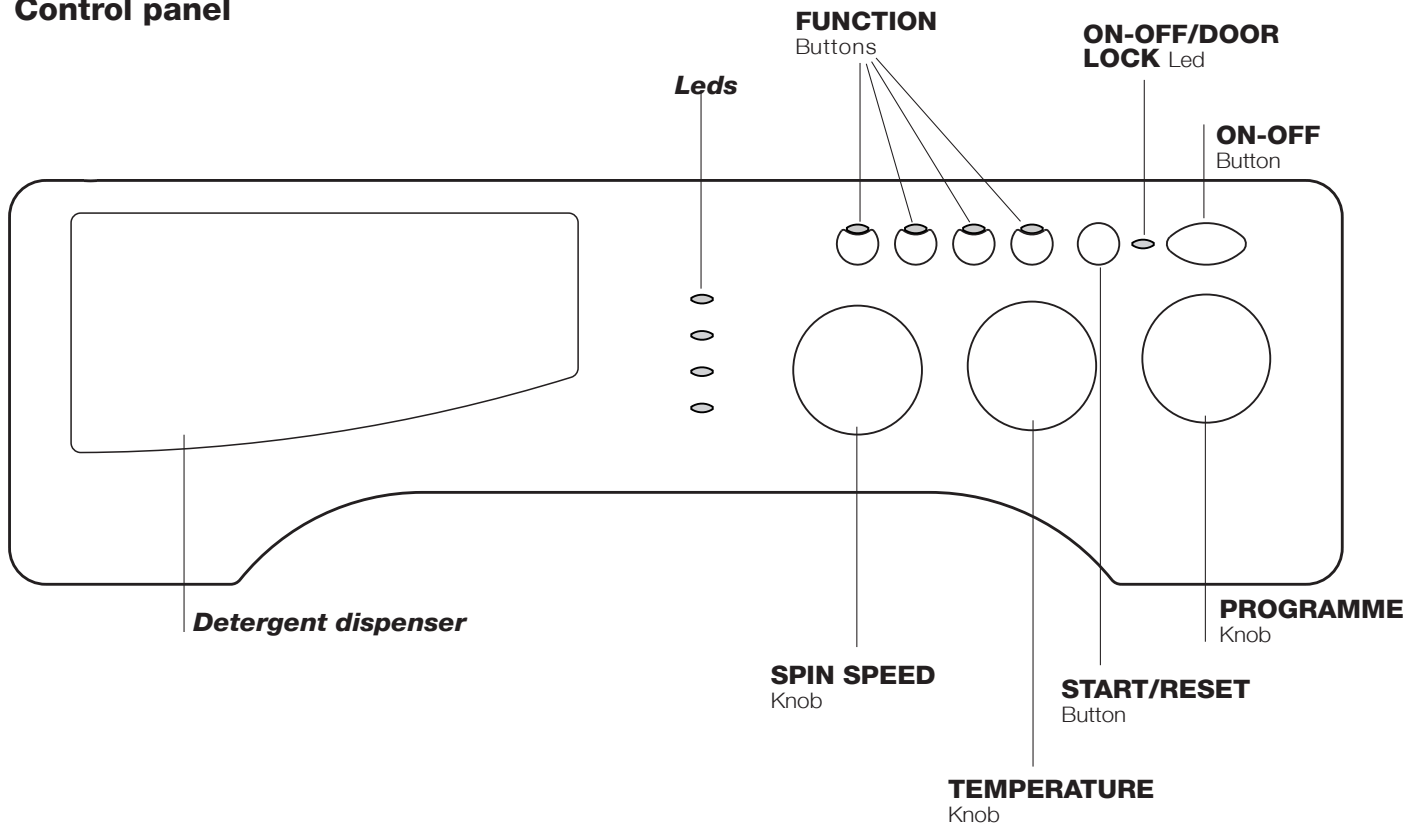

Detergent dispenser: to add detergent and fabric softener.

LEDS: to find out which wash cycle phase is under way. If the Delay Timer function has been set, the time left until the programme starts will be indicated.

SPIN SPEED knob: to set the spin speed or exclude the spin cycle completely.

FUNCTION buttons: to select the functions available. The button corresponding to the function selected will remain on.

TEMPERATURE knob: to set the temperature or the cold wash cycle.

START/RESET button: to start the programmes or cancel any incorrect settings.

ON-OFF/DOOR LOCK Led: to find out whether the washing machine is on and if the appliance door can be opened.

ON/OFF button: to turn the washing machine on and off.

PROGRAMME knob: to select the wash programmes. The knob stays still during the cycle.

Standby mode

This washing machine, in compliance with new energy saving regulations, is fitted with an automatic standby system which is enabled after about 30 minutes if no activity is detected. Press the ON-OFF button briefly and wait for the machine to start up again.

Leds

The LEDS provide important information.
This is what they can tell you:

Delay set:

If the Delay Timer function has been enabled, once you have started the programme, the LED corresponding to the delay set will begin to flash:



As time passes, the remaining delay will be displayed, and the corresponding LED will flash:

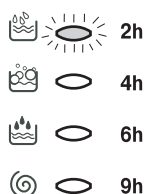

Once the set delay is complete, the flashing LED will turn off and the programme set will start.

Cycle phase under way:

During the wash cycle, the LEDs gradually illuminate on to indicate the cycle phase under way:

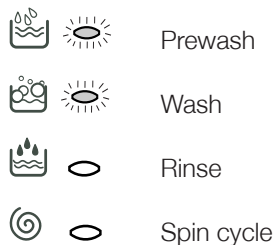

Note: during draining, the LED corresponding to the Spin cycle phase will be turned on.

Function buttons

The FUNCTION BUTTONS also act like LEDS.

When a function is selected, the corresponding button is illuminated.

If the function selected is incompatible with the programme set, the button will flash and the function will not be enabled.

If you set a function that is incompatible with another function you selected previously, only the last one selected will be enabled.

ON-OFF/DOOR LOCK led:



If this LED is on, the appliance door is locked to prevent it from being opened accidentally; to avoid any damages, wait for the LED to flash before you open the appliance door.

! The rapid flashing of the ON-OFF/DOOR LOCK Led together with the flashing of at least one other LED indicates there is an abnormality.



Starting and Programmes

GB

Briefly: starting a programme

1. Switch the washing machine on by pressing button . All the LEDs will light up for a few seconds and the ON-OFF/DOOR LOCK Led will begin to flash.
2. Load your laundry into the washing machine and shut the appliance door.
3. Set the PROGRAMME knob to the programme required.
4. Set the wash temperature.
5. Set the spin speed.
6. Add the detergent and any fabric softener.
7. Start the programme by pressing the START/RESET button. To cancel it, keep the START/RESET button pressed for at least 2 seconds.
8. When the programme is finished, the ON-OFF/DOOR LOCK Led will flash to indicate that the appliance door can be opened. Take out your laundry and leave the appliance door ajar to allow the drum to dry thoroughly. Turn the washing machine off by pressing button .

Programme table

Wash cycles	Description of the wash cycle	Max. temp. (°C)	Max. speed (rpm)	Detergents				Max. load (kg)	Residual dampness %	Energy consumption kWh	Total water lt	Cycle duration
				Prewash	Wash	Fabric softener	Bleach					
Standard												
1	White prewash: extremely soiled whites.	90°	1200	●	●	●	-	7	-	-	-	180'
2	White Cotton: extremely soiled whites.	90°	1200	-	●	●	●	7	-	-	-	150'
3	Colour Cotton: lightly soiled whites and delicate colours.	40°	1200	-	●	●	●	7	-	-	-	100'
4	Easy care: heavily soiled resistant colours.	50°	1000	-	●	●	●	3,5	-	-	-	115'
4	Easy care: (3): lightly soiled resistant colours.	40°	1000	-	●	●	●	3,5	46	0.64	53	120'
5	Cotton Standard 60°C (1): heavily soiled whites and resistant colours.	60°	1200	-	●	●	●	7	53	1.16	52.5	205'
6	Cotton Standard 40°C (2): lightly soiled whites and delicate colours.	40°	1200	-	●	●	●	7	53	0.97	75	220'
7	Wool: for wool, cashmere, etc.	40°	800	-	●	●	-	1,5	-	-	-	70'
8	Cotton Standard 20°C: lightly soiled whites and delicate colours.	20°	1200	-	●	●	●	7	-	-	-	170'
Time 4 you												
9	Flash Clean: Heavily soiled whites and fast colours	60°	1200	-	●	●	-	3,5	-	-	-	60'
10	Flash Colours: Lightly soiled whites and delicate colours (shirts, jumpers, etc.)	40°	1200	-	●	●	-	3,5	-	-	-	50'
11	Flash Nylon: Delicate colours (all types of slightly soiled garments)	40°	1000	-	●	●	-	2,5	-	-	-	40'
12	Daily: to refresh lightly soiled garments quickly (not suitable for wool, silk and clothes which require washing by hand).	30°	800	-	●	●	-	3	70	0.16	33	30'
Sport												
13	Special Shoes	30°	600	-	●	●	-	Max. 2 pairs	-	-	-	50'
14	Special Sport	30°	600	-	●	●	-	2,5	-	-	-	60'
Partial programmes												
	Rinse	-	1200	-	-	●	●	7	-	-	-	50'
	Spin + Drain	-	1200	-	-	-	-	7	-	-	-	10'

The length of cycle shown on the display or in this booklet is an estimation only and is calculated assuming standard working conditions. The actual duration can vary according to factors such as water temperature and pressure, the amount of detergent used, the amount and type of load inserted, load balancing and any wash options selected.

1) Test wash cycle in compliance with regulation 1061/2010: set wash cycle 5 with a temperature of 60°C.

This cycle is designed for cotton loads with a normal soil level and is the most efficient in terms of both electricity and water consumption; it should be used for garments which can be washed at 60°C. The actual washing temperature may differ from the indicated value.

2) Test wash cycle in compliance with regulation 1061/2010: set wash cycle 6 with a temperature of 40°C.

This cycle is designed for cotton loads with a normal soil level and is the most efficient in terms of both electricity and water consumption; it should be used for garments which can be washed at 40°C. The actual washing temperature may differ from the indicated value.

For all Test Institutes:

2) Long wash cycle for cottons: set wash cycle 6 with a temperature of 40°C.

3) Long wash cycle for synthetics: set wash cycle 4; with a temperature of 40°C.

Notes

-For programmes 9 and 10, we advise against exceeding a wash load of 3.5 kg.

-For programme 14 we advise against exceeding a wash load of 2,5 kg.

Cotton Standard 20° (wash cycle 8) ideal for lightly soiled cotton loads. The effective performance levels achieved at cold temperatures, which are comparable to washing at 40°, are guaranteed by a mechanical action which operates at varying speed, with repeated and frequent peaks.

Daily (programme 12 for Synthetics) is designed to wash lightly soiled garments in a short amount of time: it only lasts 30 minutes and allows you to save on both time and energy. By setting this programme (13 at 30°C), you can wash different fabrics together (except for woollen and silk items), with a maximum load of 3 kg. We recommend the use of liquid detergent.

Setting the temperature

Turn the TEMPERATURE knob to set the wash temperature (see Programme table).
The temperature can be lowered, or even set to a cold wash (❄).

Setting the spin speed

Turn the SPIN SPEED knob to set the spin speed for the programme selected.
The maximum spin speeds for each programme are as follows:

Programmes	Maximum spin speed
Cottone	1200 rpm
Synthetics	1000 rpm
Wool	800 rpm
Silk	no

The spin speed can be lowered, or the spin cycle can be excluded altogether by selecting symbol

The washing machine will automatically prevent you from selecting a spin speed higher than the maximum speed for each programme.

Note: to avoid excessive vibrations, before every spin cycle the machine distributes the load in a uniform manner by continuously rotating the drum at a speed which is slightly faster than the normal washing speed.

When, despite repeated attempts, the load is still not evenly distributed, the machine spins at a lower speed than the set frequency.

If the load is excessively unbalanced, the machine attempts to distribute it instead of spinning.

The balancing attempts may extend the total duration of the cycle, up to a maximum of 10 minutes.

Functions

To enable a function:

1. press the button corresponding to the desired function, according to the table below;
2. the function is enabled when the corresponding button is illuminated.

Note:

- If the function selected is incompatible with the programme set, the button will flash and the function will not be enabled.
- If you set a function that is incompatible with another function you selected previously, only the last one selected will be enabled.

Option	Effect	Comments
 Delay Timer	Delays the start of the wash by up to 9 hours.	Press the button repeatedly until the LED corresponding to the desired delay is turned on. The fifth time the button is pressed, the function will be disabled. N.B.: Once you have pressed the Start/Reset button, the delay can only be decreased if you wish to modify it.
 Bleaching	Bleaching cycle designed to remove the toughest stains.	Please remember to pour the bleach into extra compartment 4 (see page 14). This option is incompatible with the EASY IRON option.
 Easy iron	By selecting this function, the wash and spin cycles will be modified in order to reduce the formation of creases. At the end of the cycle the washing machine will perform slow rotations of the drum.	- to conclude the cycle, press the START/RESET button; - to run the draining cycle alone, set the knob to the relative symbol and press the START/RESET button. This option is incompatible with the BLEACHING option.
 Extra Rinse	Increases the efficiency of the rinse.	Recommended when the appliance has a full load or with large quantities of detergent.

Detergents and laundry

GB

Detergent dispenser

Good washing results also depend on the correct dose of detergent: adding too much detergent won't necessarily make for a more efficient wash, and may in fact cause build up on the interior of your appliance and even pollute the environment.

! Do not use hand washing detergents because these create too much foam.

! Use powder detergent for white cotton garments, for pre-washing, and for washing at temperatures over 60°C.

! Follow the instructions given on the detergent packaging.

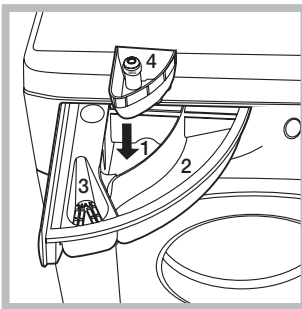

Open up the detergent dispenser and pour in the detergent and fabric softener, as follows.

compartment 1: Detergent for pre-wash (powder)

Before pouring in the detergent, make sure that extra compartment 4 has been removed.

compartment 2: Detergent for the wash cycle (powder or liquid)

Liquid detergent should only be poured in immediately prior to the wash cycle start.

compartment 3: Additives (fabric softeners, etc.)

The fabric softener should not overflow from the grid.

extra compartment 4: Bleach

! Do not use hand wash detergent because it may form too much foam.

Bleach cycle

! **Traditional** bleach should be used on sturdy white fabrics, and **delicate** bleach for coloured fabrics, synthetics and for wool.

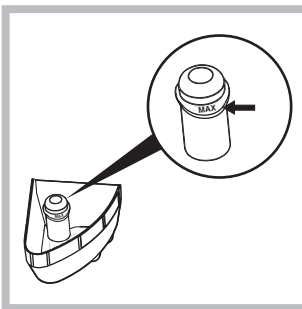

Place extra compartment 4, provided, into compartment 1.

When pouring in the bleach, be careful not to exceed the "max" level indicated on the central pivot (see figure).

To run the bleach cycle alone, pour the bleach into extra compartment 4, set the Rinse programme  and enable the "Bleaching" option. To bleach during a wash cycle, pour in the detergent and fabric softener, set the desired programme and enable the "Bleaching" option (see page 13). The use of extra compartment 4 excludes the possibility of using the pre-wash cycle.

Preparing your laundry

- Divide your laundry according to:
 - the type of fabric/the symbol on the label.
 - the colours: separate coloured garments from whites.
- Empty all pockets and check for loose buttons.
- Do not exceed the values listed in the "Table of wash cycles", which refer to the weight of the laundry when dry.

How much does your laundry weigh?

- 1 sheet 400-500 g
- 1 pillow case 150-200 g
- 1 tablecloth 400-500 g
- 1 bathrobe 900-1,200 g
- 1 towel 150-250 g

Special items

Wool: the wool wash cycle of this machine has been tested and approved by The Woolmark Company for the washing of wool containing garments labelled as "hand wash" provided that the garments are washed according to the instructions on the garment label and those issued by the manufacturer of this washing machine. (M1126)



In UK, Eire, Hong Kong and India the Woolmark trade mark is a Certification trade mark.

Your washing machine could fail to work. Before calling for Assistance (see page 16), make sure the problem can't easily be solved by consulting the following list.

Problem

The machine does not switch on.

Possible causes/Solution:

- The appliance is not plugged into the socket fully, or not enough to make contact.
- There is no power to the socket, or the fuse has blown in the mains plug.

The wash cycle does not start.

- The door is not closed properly.
- The 'ON/OFF' button has not been pressed.
- The 'START/RESET' button has not been pressed.
- The water tap has not been turned on to allow water to flow into the machine.
- A delayed start has been set.



The machine does not fill with water.

- The water inlet hose is kinked.
- The water inlet hose is not connected to the water supply.
- The water pressure is too low.
- The water tap has not been turned on to allow water to flow into the machine.
- There is no water supply to the house.
- The inlet valve filter is blocked.
- The 'START/RESET' button has not been pressed.

The machine continuously fills with water and continually drains away or Water left in the drum or Stuck on wash.

- The top of the drain hose is too low - It must be fitted at a height between 65 and 100 cm from the floor.
- The drain hose is connected incorrectly to the sink trap allowing water to run into the machine, the drain hose must be positioned higher than the bottom of the sink to prevent water flowing down the drain hose.
- The end of the drain hose has been pushed too far down the standpipe, the 'U' bracket should be fitted 100 mm from the end of the drain hose.

The machine does not drain or spin.

- The Pump filter is blocked.
- The "Easy iron" function is enabled: to complete the programme, press the START/RESET button (see page 13).
- The drain hose is kinked.
- New Installation - The blanking cap or spigot has not been removed if connected under a sink.
- The drain hose or sink trap is blocked.
- The wash cycle does not include draining, some wash cycles require the drain phase to be started manually.
- The 'Spin Speed' selector knob is in the  position.
- The 'Temperature' selector knob is in the  position.

The machine does not heat or poor wash results.

The programme takes too long.

- Programme times will vary due to water pressure, the incoming water temperature and if the wash load goes out of balance. This will increase the programme times accordingly (see 'The machine won't spin properly' next page).

The machine vibrates a lot during the spin cycle.

- The feet have not been adjusted, enabling the machine to rock.
- New Installation - Either the Transit Bolts including the plastic spacers, or the Polystyrene Packaging have not been removed when installing the machine.
- The machine is trapped between cabinets and/or walls.
- The load is in a slight out of balance condition and machine is spinning, but at a lower speed.

The machine is noisy.

- There will always be some motor, pump and drum noise during spin.

The machine wont spin properly.

- Out of Balance detected when attempting to go into a spin cycle - If this happens the machine will continue to try to repeat the distribution of the load required before the machine will go into higher spin speeds - This will increase the programme time accordingly. This is a safety feature to prevent damage. Out of Balance can be caused by washing a single heavy item (eg duvet, quilt, etc). - Try the programme again using a different load.

The machine leaks from the dispenser.

- The dispenser drawer is blocked with detergent and requires cleaning.
- The water pressure is too high and requires turning down - turn down the tap on the water supply pipe slightly and try again.
- The machine is tilting forwards - It must be level when in its final position.

The machine leaks (other than dispenser).

- The fill hose is loose, check both the cabinet and tap ends.
- The fill hose is tight but still leaks, if so replace the rubber washers, or the fill hose is missing the rubber washer.
- The drain hose is not fixed in properly.

The indicator lights on the console are flashing rapidly.

- Switch off the machine and unplug it, wait for approximately 1 minute and then switch it back on again. If the problem persists contact the Technical Assistance Service.

The machine smells.

- The machine requires a service wash. Run a 90 degree wash cycle with detergent and no laundry.

The machine door cannot be opened.

- The door will not open until the door lock indicator light goes out shortly after the program has finished.

Door Seal damaged at the bottom.

- The door seal has drainage holes at the bottom - This is normal.

There is too much foam.

- The detergent is not suitable for machine washing (it should display the text 'for washing machines' or 'hand and machine wash' or the like).

After completing the programme, or before starting a programme, the machine has turned itself off (no lights).

- To comply with new energy saving regulations the machine is fitted with an automatic standby system. Press 'ON/OFF' button for 3 seconds to activate the machine, it can then either be switched off or a new programme selected.

General.

- Your washing machine contains sensors that monitor progress during the wash cycle (eg: Water Levels, Temperatures, Out of Balance loads, Wash time/progress). Normally, if your machine successfully completes the cycle, there is unlikely to be anything wrong!

Remember, you will be charged for a service call for problems caused by incorrect installation, as indicated on pages 2 to 4.

Not emptying contents from pockets may cause pump or drain blockages, or may damage the machine. Do not wash items which do not have a wash label, or wash items that are not intended as machine washable.